

## ALP™ G2

## Area and Site Light



### DESCRIPTION

Delivering upto 85,000 lumens, ALP™ G2 can replace 100W to 1500W metal halide, making it one of the most versatile fixtures currently available. Standard features include a pressure release valve, 10kV surge protection, and tool-less entry for easy maintenance. Multiple distribution patterns are available, which deliver light at a maximum efficiency of 160 LpW. An extensive selection of accessories, including photocell receptacles, motion sensor, shields, finish colors, mounts, and backlight control louvers make ALP G2™ the ideal choice for superior illumination of outdoor areas.

### APPLICATIONS

Commercial Parking Lots, Pedestrian Pathways, Street Lighting, Site and Recreational Sports



### FEATURES

#### Construction

Rugged die-cast aluminum housing.  
Modular lighting engine: IP67 Rating

#### Finish

Dark Bronze (Standard), White, Grey, Black

#### EPA Rating/Enclosure Rating

EPA: See Page 4.  
Enclosure: IP66 Rating

#### Operating Temperature

-40°F~113°F

#### Electrical

Input Voltage: 120-277V or 277-480V (Optional)  
Projected L70> 140,000 hrs  
Surge Protection:  
- 10kV Standard  
- 20kV Optional

#### Power Factor

>0.9

#### Controls

1-10V Dimming standard.  
Bi-level Occupancy/Daylight Harvesting Sensor available.  
Photocell options available.  
Dimulator Dimming Photocontrol available.  
Radiant Wireless Control System available.

#### Optical System

Available in distribution:  
Type II, Type III, Type IV, and Type V

#### CCT

3000K, 4000K, 5000K, 5700K

#### CRI

≥70

#### Installation/Mounting

See Page 3.

#### Warranty

5 Year Warranty.  
See warranty documentation for more information.



IP66  
Fixture



Dark Sky  
Friendly  
(Zero Uplight/  
3000K)



Photocell  
Option



Bi-Level  
Occupancy/  
Daylight  
Harvesting  
Sensor Option

## Ordering Information

### EXAMPLE: ALP2-200-50-3-U-SLA-D-D0

Series	Wattage	CCT	Distribution	Input Voltage	Mount	Finish	Control
ALP2	80 - 80W	30 - 3000K 40 - 4000K 50 - 5000K 57 - 5700K	2 - Type II 3 - Type III 4 - Type IV 5 - Type V	U - 120-277VAC H - 277-480VAC	SLA (For 2 3/8" Round Tenon) SLB (For 1.57" Round Tenon) SLD (For Square Pole) SLE (For Round Pole)	D - Dark Bronze *G - Gray *B - Black *W - White	D0 (Without Control Sensors)
	100 - 100W						D1 (Radiant Wireless Control System)
	120 - 120W						D1-5SC (5 Pin Receptacle W/Shortcap)
	150 - 150W						D1-5PC (5 Pin Receptacle W/On/Off Photocell)
	200 - 200W						D1-7SC (7 Pin Receptacle W/Shortcap)
	240 - 240W						D1-7PC (7 Pin Receptacle W//On/Off Photocell)
	320 - 320W						D4 (Bi-level Occupancy/Daylight Harvesting Sensor)
	400 - 400W						DIM4-U - Dimulator 120-277 VAC with 7 pin
	500 - 500W						DIM4-H - Dimulator 480VAC with 7 pin
	600 - 600W						<b>Accessories</b>
	ALP2-TRU (Trunnion)	ALP2-S-BLS (Back Light Shield [80W~200W])	FDP-301-L2-G (Network Motion Sensor)				
	ALP2-TEN (Wall Mount Tenon)	ALP2-M-BLS (Back Light Shield [240W-600W])	FDP-301-L2-W (Network Motion Sensor)				
	ALP2-FS (Field Adjustable Lumen Switch)	ALP2-S-FLS (Full Light Spill Shield [80W~200W])	FDP-301-L7-G (Network Motion Sensor)				
	SP-U-20kV (20kV/10kA Surge Protection [120-277V])	ALP2-M-FLS (Full Light Spill Shield [240W-600W])	FDP-301-L7-W (Network Motion Sensor)				
	SP-H-20kV (20kV/10kA Surge Protection [277-480V])	∅ALP2-S-BLC (Back Light Control [80W~320W])					
		∅ALP2-M-BLC (Back Light Control [400W~600W])					
		∅Note: Back Light Control sold as individual units: • ALP2-S-BLC [2 units per fixture (80W~200W)] • ALP2-S-BLC [3 units per fixture (240W~320W)] • ALP2-M-BLC [3 units per fixture (400W~600W)]					

Specifications and Dimensions subject to change without notice.

\*MOQ and longer lead times may apply, please contact customer service for more information.

Optional accessories sold separately.

Features

**Constructions**

- IP66 Die-cast Aluminum Housing
- Modular Design For Easy Installation, Replacement, & Maintenance
- Sleek Low Profile Design: Low EPA Rating

**Finish**

- Corrosion Resistant Polyester
- Standard Finish: Dark Bronze
- Available Finish:



Dark Bronze  
Pantone:  
Black 7 U



Gray  
Pantone:  
Cool Gray 3 U



Black  
Pantone:  
Black 3 C



White  
Pantone:  
663 M

**LED Module**

- IP67 LED Module
- Type II, III, IV, V Distribution



**Mounting**

- Standard Mounting Diameter: 2 3/8" (60mm)
- 6 Mounting Options
- Adjustable Mounting

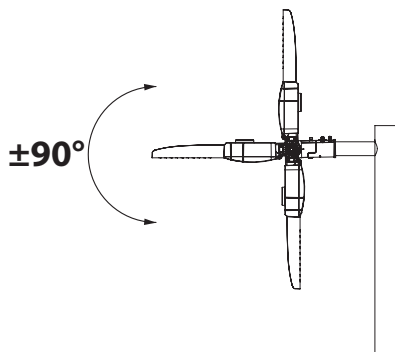

**Pressure Release Valve**

- Release Pressure To Prevent Moisture Buildup

**Accessories**

- Multiple Light Spill Shield Available



**Electrical/Control**

- 120-277VAC & 277-480VAC Available
- Dimulator Dimming Photocontrol, Photocell, or Bi-level Occupancy/Daylight Harvesting Sensor Available
- Surge Protection:
  - 10kV Standard
  - 20kV Optional
- Radiant Wireless Control System

**Tool-less Driver Compartment**

- Convenient Tool-less Driver Compartment Release For Quick Wiring & Service



**Bracket Installation**

SLA (For 2 3/8" Round Tenon)

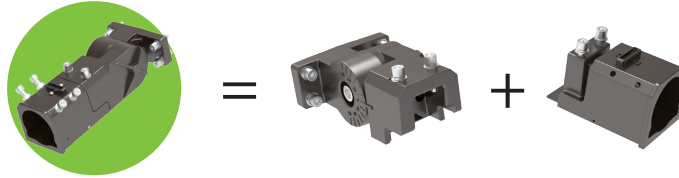

SLB (For 1.57" Round Tenon)

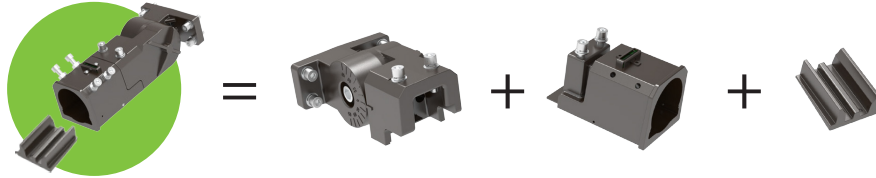

SLD (For Square Pole)

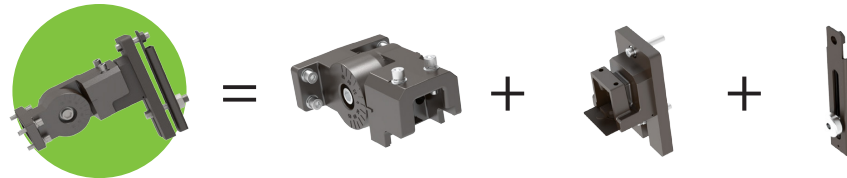

SLE (For Round Pole)

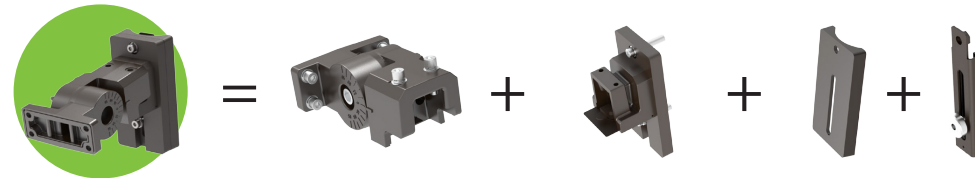

SLA or SLB — Different O.D. Tenon Mount

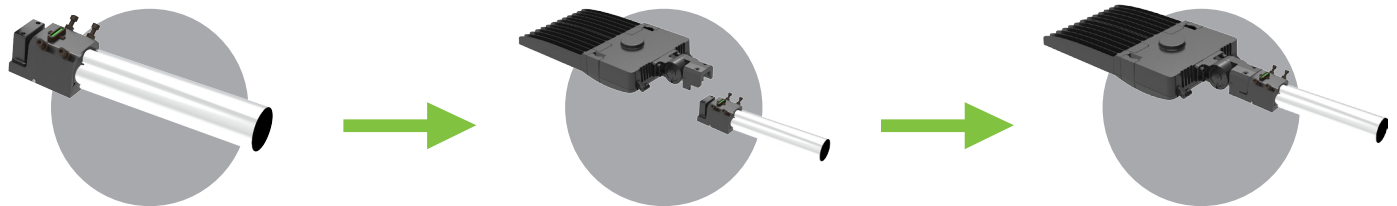

SLD — Square Pole Mount

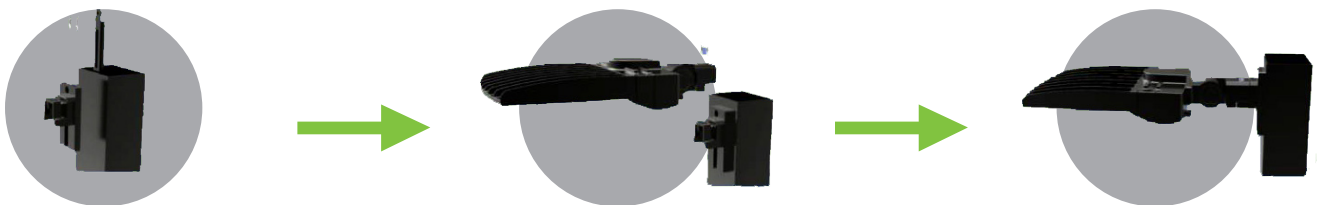

SLE — Round Pole Mount

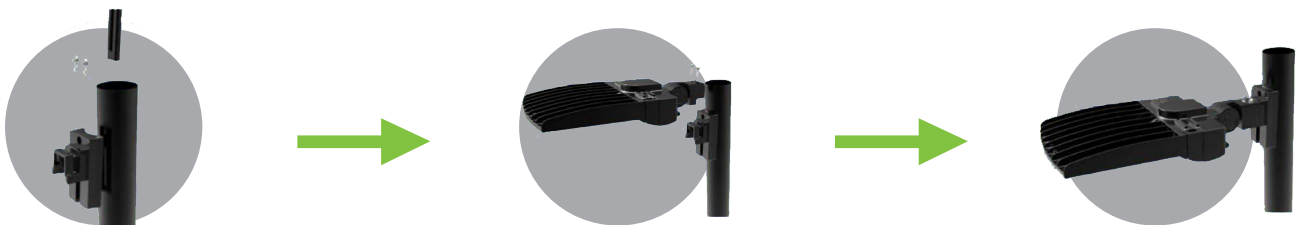

Technical Detail

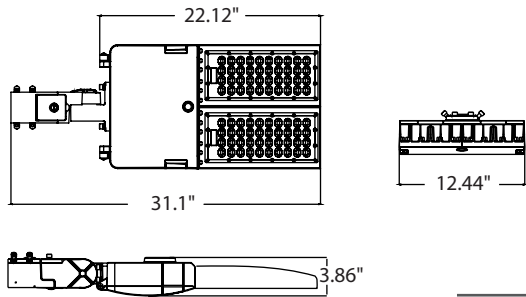

**EPA: 0.5ft<sup>2</sup>**

Net weight: 21.3 lbs.

Gross weight : 24.0 lbs.

Product Dimension: 31.1"x12.44"x3.86"

Wattage	*System Efficacy	
	3000K	4000K/5000K/5700K
80W	150lm/W	160lm/W
100W	150lm/W	160lm/W
120W	140lm/W	155lm/W
150W	140lm/W	155lm/W
200W	140lm/W	150lm/W

Configuration	1	2@180°	2@90°	3@90°	3@120°	4@90°
EPA (ft <sup>2</sup> )	0.50	1.00	0.77	1.27	0.93	1.27
Weight (lbs.)	21.3	42.6	42.6	63.9	63.9	85.2

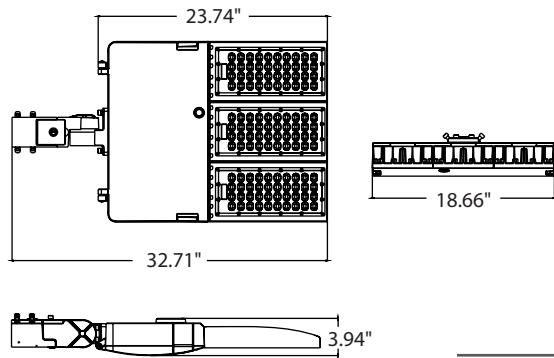

**EPA: 0.53ft<sup>2</sup>**

Net weight: 26.9 lbs.

Gross weight : 30.4 lbs.

Product Dimension: 32.7"x18.66"x3.94"

Wattage	*System Efficacy	
	3000K	4000K/5000K/5700K
240W	145lm/W	160lm/W
320W	135lm/W	150lm/W

Configuration	1	2@180°	2@90°	3@90°	3@120°	4@90°
EPA (ft <sup>2</sup> )	0.53	1.06	0.96	1.49	0.99	1.49
Weight (lbs.)	26.9	53.8	53.8	80.7	80.7	107.6

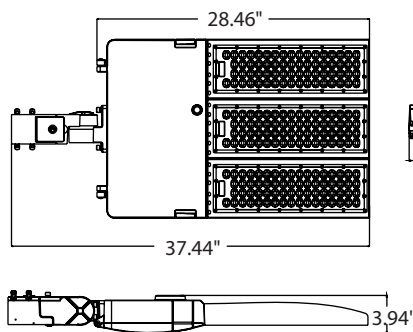

**EPA: 0.6ft<sup>2</sup>**

Net weight: 33.0 lbs.

Gross weight : 37.0 lbs.

Product Dimension: 37.44"x18.66"x3.94"

Wattage	*System Efficacy	
	3000K	4000K/5000K/5700K
400W	140lm/W	150lm/W
500W	130lm/W	135lm/W
600W	130lm/W	135lm/W

Configuration	1	2@180°	2@90°	3@90°	3@120°	4@90°
EPA (ft <sup>2</sup> )	0.60	1.20	1.03	1.63	1.12	1.63
Weight (lbs.)	33.0	66.0	66.0	99.0	99.0	132.0

**Performance Table**

**Lumen Output**

Lumen value are from photometric test performed in accordance with IESNA LM-70-08. Data is considered to be representative of the configurations shown, within the tolerances allowed by Lighting Facts Contact factory for performance data on any configurations not shown here.

System Watts	Dist. Type	3000K				4000K				5000K			
		Lumens	B	U	G	Lumens	B	U	G	Lumens	B	U	G
80W	2					13390	3	0	2				
	3					13203	2	0	2				
	4					13127	2	0	3				
	5					12766	3	0	2				
100W	2					16332	3	0	2				
	3					16274	2	0	2				
	4					15961	3	0	2				
	5					15860	3	0	3				
120W	2	17205	3	0	3	17511	3	0	2	17983	3	0	2
	3	17324	2	0	2	17853	3	0	2	18396	2	0	2
	4	17514	3	0	2	17604	3	0	2	17974	3	0	2
	5	17893	4	0	2	18369	4	0	2	18601	4	0	2
150W	2	21297	3	0	3	21813	3	0	3	22381	3	0	3
	3	21448	3	0	3	22345	3	0	3	22907	3	0	3
	4	21058	3	0	3	22225	3	0	3	22401	3	0	3
	5	21603	4	0	2	22729	4	0	2	23289	4	0	2
200W	2	27891	3	0	3	28524	3	0	3	29358	3	0	3
	3	27944	3	0	3	28954	3	0	3	29612	3	0	3
	4	27083	3	0	3	28564	3	0	3	29221	3	0	3
	5	27561	5	0	3	29729	5	0	3	30264	5	0	3
240W	2	34805	4	0	3	36651	4	0	3	37339	4	0	3
	3	35476	3	0	4	36527	4	0	4	37955	4	0	4
	4	34854	4	0	4	37052	4	0	4	37685	4	0	4
	5	35529	5	0	5	37720	5	0	4	38930	5	0	3
320W	2	44481	4	0	3	45022	4	0	4	48034	4	0	3
	3	42375	4	0	4	44784	4	0	4	46333	4	0	4
	4	42401	4	0	4	45096	4	0	4	46150	4	0	4
	5	42859	5	0	3	46772	5	0	4	48317	5	0	4
400W	2	55736	5	0	5	58008	5	0	4	59172	5	0	4
	3	55611	5	0	5	57664	5	0	5	59443	5	0	5
	4	56058	5	0	4	57883	5	0	5	59168	5	0	4
	5	57085	5	0	4	59260	5	0	4	61459	5	0	4
500W	2	65018	5	0	4	67761	5	0	4	69196	5	0	4
	3	63624	5	0	5	66690	5	0	5	67478	5	0	5
	4	63963	5	0	5	65758	5	0	5	67807	5	0	5
	5	65463	5	0	4	67945	5	0	5	69639	5	0	4
600W	2	84855	5	0	5	84805	5	0	5	84803	5	0	5
	3	79985	5	0	5	84545	5	0	5	84545	5	0	5
	4	80652	5	0	5	84802	5	0	5	84803	5	0	5
	5	81095	5	0	4	85252	5	0	4	85257	5	0	4

**Photometric Data**

Multiplier	Mounting Height
2.8	15'
1.6	20'
1.0	25'
0.7	30'
0.5	35'

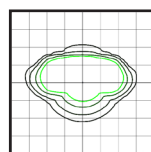

Type II

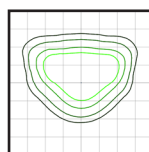

Type III

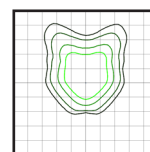

Type IV

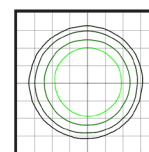







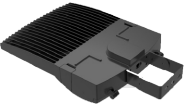

Type V

\* IESNA LM-63 IES Available

Electrical Load

System Wattage (W)	Current (A)					
	120V	208V	240V	277V	347V	480V
80	0.67	0.38	0.33	0.29	0.23	0.17
100	0.83	0.48	0.42	0.36	0.29	0.20
120	1.00	0.58	0.50	0.43	0.34	0.25
150	1.25	0.72	0.63	0.54	0.43	0.31
200	1.68	0.96	0.83	0.72	0.57	0.42
240	2.00	1.15	1.00	0.87	0.69	0.50
320	2.67	1.54	1.33	1.16	0.92	0.67
400	3.33	1.92	1.67	1.44	1.15	0.83
500	4.17	2.40	2.08	1.81	1.44	1.04
600	5.00	2.88	2.50	2.16	1.72	1.25

Accessories

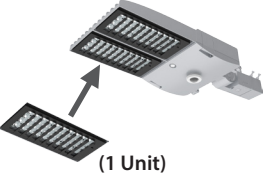
	<b>Trunnion</b>		ALP2-TRU		<b>Back Light Shield</b>	ALP2-S-BLS (80W~200W) ALP2-M-BLS (240W~600W)
	<b>Photocell or Dimulator Dimming Photocontrol</b>		D1		DIM4-X	
	<b>Bi-level Occupancy/Daylight Harvesting Sensor</b>		D4		FDP-301	
					<b>Back Light Control</b>	ALP2-S-BLC (80W~320W) ALP2-M-BLC (400W~600W) [80W~200W (2 UNITS)] [240W~320W (3 UNITS)] [400W~600W (3 UNITS)] (Sold as individual Units)

Control Pre-Commissioning

Default settings are indicated by \*

Sensitivity Range	Time Delay	Daylight Harvesting	Stand-by Light Level Setting	Stand-by Time Setting
20%	10s	*Light sensor disabled	0%	∞
50%	1min	1 FC (10lux)	*10%	1min
75%	*5min	3 FC (30lux)	30%	30min
*100%	15min	5 FC (50lux)	50%	*60min

**Sensitivity Range:**  
Setting that determines the range of the motion sensor when the daylight sensor is disable.

**Time Delay:**  
The light can be set to stay ON for any period of time between approx. 10sec and the maximum of 60 min. Any movement detected before this time elapses will re-start the timer.

**Daylight Harvesting:**  
The chosen light response threshold can be infinitely from approx. 1-5 FC.

**Stand-by Light Level:**  
Setting determines how much lumen output is dimmed down to when no motion is detected.

**Stand-by Time:**  
Setting determines how long after stand-by light level occurs the light will shut off. Up to 60 minutes.

## Photocontrol Option

### ELL Photocell Extra Long Life Photocontrol (Standard)



#### Features

- Designed to meet or exceed the life expectancy of LED fixtures.
- 10 Year Warranty
- 40kV Surge Protection
- High voltage version available

#### Bat Eye Technology

- Advanced light sensor, only reacts to sunlight
- Immune to LED and other artificial light
- No false activation (no cycling)
- May be oriented in any direction



### Dimulator Stand-Alone LED Dimming Photocontrol



#### Features

- Factory preset dimming - no selector switch
- 10 Year Warranty
- Compliant with ANSI C136.41 receptacle
- Optional constant all night dimming
- Adaptive lighting control with progressive intensities
- 40kV Surge Protection
- High voltage version available
- Advance time/date algorithm auto-adjusts for daylight savings
- Automatically synchronize to local time

#### Bat Eye Technology

- Advanced light sensor, only reacts to sunlight
- Immune to LED and other artificial light
- No false activation (no cycling)
- May be oriented in any direction



Patent #9210746

# RADIANT™

WIRELESS CONTROL SYSTEM



- Utility grade power monitoring.
- WiFi Mesh Receiver Nodes.
- Communication range is up to 1 mile line of sight.
- Control dimming and On/Off.
- Secure, over-the-air software upgrades.



- Manual/Remote/Web access to Nodes.
- Control up to 1000 Nodes.
- Weather protected.
- Optional, pre-configured 5 button switch to allow for control of all lighting (Central Base Station only).



Wattstopper FDP-301  
Network Controlled  
Sensor  
(Optional)

Central Control Station  
(Optional)

or SimplySnap Controller

WiFi or LAN Network  
with  
browser based  
control interface

Optional Cloud Control  
with Verizon 4G LTG

## Wattstopper FSP-301 Network Controlled Motion Sensor

**L2 Lens** The FDP-L2 is designed for mounting at heights between 8'-15'. It provides 48' diameter coverage area when mounted at height 8' or a 78' coverage area at 15'.

Top View @ 8'

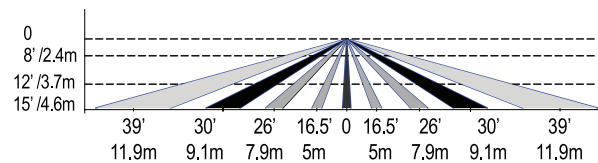
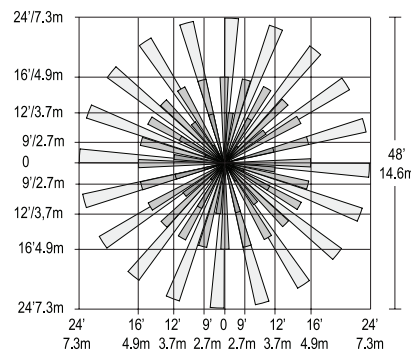

**L7 Lens** The FDP-L7 has a lens that covers a 100' diameter area at a height of 40'.

Top View @ 40'

